

Electro-hydraulic steering system for trailers

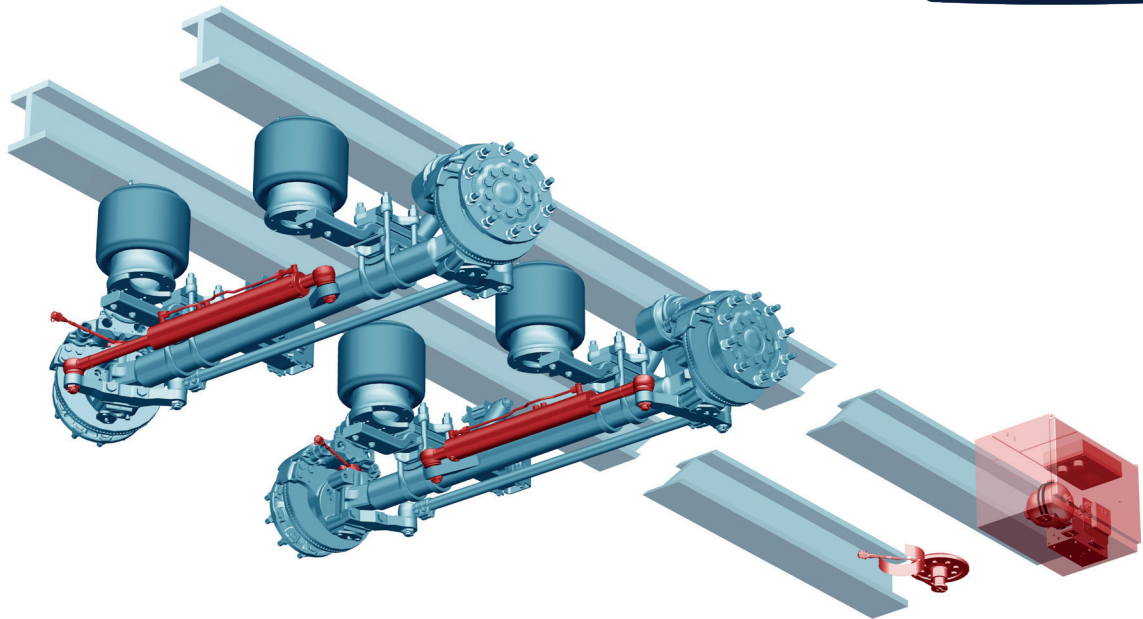

Specifications

- Customized software
- Only with engine-driven pump
- Manual control optional
- Stainless steel locker
- Standard and custom lockers
- Suitable for any axle

Type	Weight	System locker dimensions L x W x H
1M	80 kg	400 x 400 x 400 mm
2M	120 kg	600 x 400 x 400 mm
3M	190 kg	800 x 400 x 400 mm

Applications

- Distribution
- Tank transport
- Construction
- Heavy transport
- Special transport